

NEW WORK

Our solutions for hybrid and flexible working



Ergonomic analogue and digital tools which work better together

DURABLE is intensively engaged with New Work Solutions and develops innovations for hybrid, interactive forms of work and suitably designed workplaces.

With a history spanning more than 100 years, DURABLE has extensive expertise and experience in professional presentation and concepts that are used worldwide in a wide variety of professional fields of work.

With this experience we show here our answers to the new way of working. Always sustainable, ergonomic and functional thought.

Contents

- 04–05 Monitor Mounts overview
- 06–09 Monitor Mounts PRO
- 10–11 Monitor Mounts SELECT PLUS
- 12–13 Monitor Mounts SELECT
- 14–15 Laptop stands and privacy filters
- NEW** 16–17 Laptop/Monitor Stand and Desk Mat EFFECT
- 18–19 Tablet holder for table and floor
- 20–21 Tablet holder for wall
- NEW** 22–23 Tablet and Mobile Phone Holder TWIST
- 24–25 Mobile TV cart COWORKSATION®
- 26 Cable management with CAVOLINE®

Monitor mounts

For every application the optimal solution

Ensure the right posture – work ergonomically with monitor mounts.

The correct positioning of the monitor promotes ergonomics and prevents damage to health. The new range of monitor mounts from DURABLE offers ergonomic solutions for every form of screen work.















The design line: DURABLE monitor mounts PRO



The flexible solution: DURABLE monitor mounts SELECT PLUS



The space-saving all-rounders: DURABLE monitor mounts SELECT

												
	Monitor Mount PRO with arm for 1 monitor, table clamp Product # 5083 → page 7	Monitor Mount PRO with arm for 1 monitor, table grommet Product # 5084 → page 7	Monitor Mount PRO for 2 monitors, table clamp Product # 5085 → page 8	Monitor Mount PRO for 2 monitors, table grommet Product # 5086 → page 8	Monitor Mount PRO for 1 monitor and 1 tablet, table clamp Product # 5087 → page 9	Monitor Mount PRO for 1 monitor and 1 tablet, table grommet Product # 5088 → page 9	Monitor Mount PRO for 1 monitor, wall mount Product # 5089 → page 9	Monitor Mount PRO with arm for 1 monitor, wall mount Product # 5090 → page 9	Monitor Mount SELECT PLUS for 1 monitor. Incl. table clamp and table grommet Product # 5096 → page 10	Monitor Mount SELECT PLUS for 2 monitors. Incl. table clamp and table grommet Product # 5097 → page 11	Monitor Mount SELECT for 1 monitor. Incl. table clamp and table grommet Product # 5094 → page 12	Monitor Mount SELECT for 2 monitors. Incl. table clamp and table grommet Product # 5095 → page 13
Monitor/s:												
Quantity monitors	1	1	2	2	1	1	1	1	1	2	1	2
Max. size monitor	21" to 27"	21" to 27"	21" to 27"	21" to 27"	21" to 27"	21" to 27"	21" to 27"	21" to 27"	up to 32"	up to 32"	up to 27"	up to 27"
Max. weight monitor	3-8 kg	3-8 kg	2x 3-8 kg	2x 3-8 kg	3-8 kg	3-8 kg	3-8 kg	3-8 kg	8 kg	2x 8 kg	8 kg	2x 8 kg
Suitable for curved monitor/s	●	●	●	●	●	●	●	●	✗	✗	✗	✗
VESA Mount 75x75 mm or 100x100 mm	● Removable VESA mount	● Removable VESA mount	● Removable VESA mount	● Removable VESA mount	● Removable VESA mount	● Removable VESA mount	● Removable VESA mount	● Removable VESA mount	● Removable VESA mount	● Removable VESA mount	●	●
Accessories/Special features:												
MM with arm	●	●	✗	✗	✗	✗	✗	●	●	●	✗	✗
MM with tablet mount	✗	✗	✗	✗	● Tablet 7" to 13"	● Tablet 7" to 13"	✗	✗	✗	✗	✗	✗
Integrated cable management	●	●	●	●	●	●	●	●	●	●	●	●
Mounting types:												
Table grommet	✗	● Table top thickness 14-44 mm	✗	● Table top thickness 14-44 mm	✗	● Table top thickness 14-44 mm	✗	✗	● Table top thickness 10-50 mm	● Table top thickness 10-50 mm	● Table top thickness 10-75 mm	● Table top thickness 10-75 mm
Table clamp	● Table top thickness 14-44 mm	✗	● Table top thickness 14-44 mm	✗	● Table top thickness 14-44 mm	✗	✗	✗	● Table top thickness 10-50 mm	● Table top thickness 10-50 mm	● Table top thickness 10-88 mm	● Table top thickness 10-88 mm
Wall	✗	✗	✗	✗	✗	✗	●	●	✗	✗	✗	✗
Adjustability:												
Adjustment in height, depth, inclination	●	●	●	●	●	●	● (●) no height adjustment	●	●	●	●	●
360° rotatable	●	●	●	●	●	●	●	●	●	●	●	●
Certifications:												
Made in Germany	●	●	●	●	●	●	●	●	✗	✗	✗	✗
10-year warranty	●	●	●	●	●	●	●	●	✗	✗	✗	✗
IGR Certification	●	●	●	●	●	●	●	●	✗	✗	✗	✗
Mounting:												
Mounting Set incl. Tools	●	●	●	●	●	●	●	●	● Toolbox on product	● Toolbox on product	● Toolbox on product	● Toolbox on product
Material	Aluminium	Aluminium	Aluminium	Aluminium	Aluminium	Aluminium	Aluminium	Aluminium	Aluminium	Aluminium	Steel	Steel

MONITOR MOUNTS PRO

The design line



The PRO mounts are manufactured in Germany to a particularly high standard and exude timeless elegance with their award-winning design – ideal for counters, law firms and rooms accessible to the public.

PRO monitor mounts are available in eight versions – the right solution for every application. High-quality aluminium ensures lightness and durability.

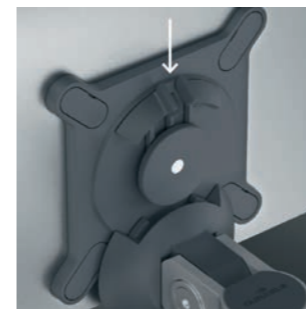

Extra easy installation of the monitor in the mount thanks to click mechanism

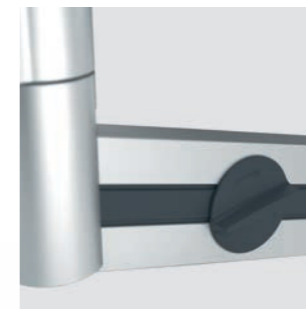

Easy adjustment to the monitor weight by rotary knob



Monitor can be rotated 360° for working in portrait or landscape mode



All monitor table mounts are available as model with table clamp or table grommet.



Table clamp for table thicknesses from 14 to 44 mm



Table grommet for table thicknesses from 14 to 44 mm and desk hole diameters from 60 to 80 mm

Monitor Mount PRO with arm for 1 screen

- For monitors from 21" to 27" (53.34 to 68.58 cm) weighing 3 to 8 kg
- Also suitable for curved monitors up to 38"
- With VESA mount 75x75 mm or 100x100 mm
- Monitor rotates 360° for working in portrait or landscape mode
- Monitor 110° tilt; 85° up, 25° down
- Rotation angle: lower arm can be rotated max. 200°, upper arm 360°
- Upper arm height adjustable from 20 to 130 mm
- Easy mounting
- Dimensions: 345x470x120 mm (WxHxD)

Code	Colour	Version	Packaging
5083-...	●23	Table clamp	1 piece
5084-...	●23	Table grommet	1 piece

MADE IN GERMANY

10 YEAR GUARANTEE



DURABLE.EU

DURABLE.EU

→ Visit durable.eu to view the entire range



The stable, space-saving table column for 2 monitors. The innovative safety system ensures that the supporting arm does not slip while adjusting the height.



Monitor Mounts PRO for the wall

- For monitors from 21" to 27" (53.34 to 68.58 cm) and 3 to 8 kg
- Also suitable for curved monitors up to 38"
- With VESA mount 75x75 mm or 100x100 mm
- Monitor rotates 360° for working in portrait or landscape mode
- Monitor tilts 110°; 85° up, 25° down

Code	Colour	Version	Packaging
5089-...	●23	without arm	1 piece
5090-...	●23	with arm	1 piece



Monitor mount PRO for 2 monitors

- For monitors from 21" to 27" (53.34 to 68.58 cm) weighing 3 to 8 kg
- With VESA mount 75x75 mm or 100x100 mm
- Monitor can be rotated 360° for working in portrait or landscape mode
- Monitor can be tilted 110°; 85° upwards, 25° downwards
- Monitor support arm height adjustable from 50 to 340 mm
- Monitors can be moved and fixed along the crossbar
- Table clamp/table grommet for table thicknesses from 14 to 44 mm
- Easy mounting with enclosed tools
- Dimensions: 780x445x190 mm (WxHxD)

Code	Colour	Version	Packaging
5085-...	●23	Table clamp	1 piece
5086-...	●23	Table grommet	1 piece

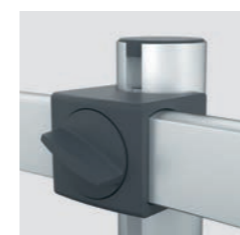

Height-adjustable monitor supporting arm, from 50 to 340 mm



Organising cables thanks to 5 individually positionable cable clamps



Monitor Mount PRO for 1 screen and 1 tablet

- For monitors from 21" to 27" (53.34 to 68.58 cm) weighing 3 to 8 kg
- Also suitable for curved monitors up to 34"
- With VESA screen mount 75x75 mm or 100x100 mm
- Monitor can be rotated 360° for working in portrait or landscape mode (can only be rotated in portrait mode up to 27")
- Monitor 110° tiltable; 85° up, 25° down
- Tablet holder for all tablets in sizes from 7" to 13"
- Tablet 360° rotatable, with snap-in points at 90°
- Support arm height adjustable 50 to 340 mm
- Screen and tablet can be moved and fixed along the crossbar
- Dimensions: 780x445x190 mm (WxHxD)

Code	Colour	Version	Packaging
5087-...	●23	Table clamp	1 piece
5088-...	●23	Table grommet	1 piece

MONITOR HOLDERS SELECT PLUS

The flexible solution

max. 32"



Monitor tilt +90° to -90°



Monitor panning +90° to -90°

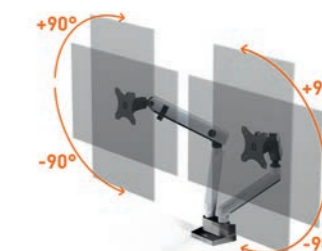

Monitor rotation +90° to -90°

Monitor Mount SELECT PLUS for 2 monitors

- For standard monitors up to 32" and 8 kg each
- Flexible to use with desk sharing or height adjustable desks
- Removable VESA mount (75x75 mm or 100x100 mm) for easy mounting
- Concealed cable routing to avoid cable breakage
- Sustainable packaging made from recycled material

Code	Colour	Version	Packaging
5097-...	23	for 2 monitors	1 piece

Included

2 mounting options:
Table clamp and
table grommet



Monitor Mount SELECT PLUS for 1 monitor

- For standard monitors up to 32" and 8 kg
- Flexible to use with desk sharing or height adjustable desks
- Removable VESA mount (75x75 mm or 100x100 mm) for easy mounting
- Concealed cable routing to avoid cable breakage
- Sustainable packaging made from recycled material

Code	Colour	Version	Packaging
5096-...	23	for 1 monitor	1 piece



Monitor tilt +90° to -90°



Monitor panning +90° to -90°

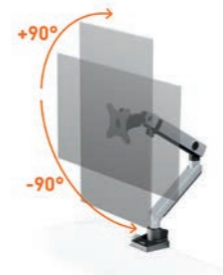

Monitor rotation +90° to -90°



Included

2 mounting options:
Table clamp and
table grommet



MONITOR MOUNTS SELECT

The space-saving all-rounders

Included

2 mounting options:
Table clamp and table grommet



Monitor Mount SELECT for 2 monitors

- For standard monitors up to 27" and 8 kg each
- Flexibly extendable up to 43 cm on a 45 cm high column
- Universal VESA mount (75x75 mm or 100x100 mm)
- Cable management with clips to protect against cable breakage
- Sustainable packaging made from recycled material

Code	Colour	Version	Packaging
5095-...	●23	for 2 monitors	1 piece

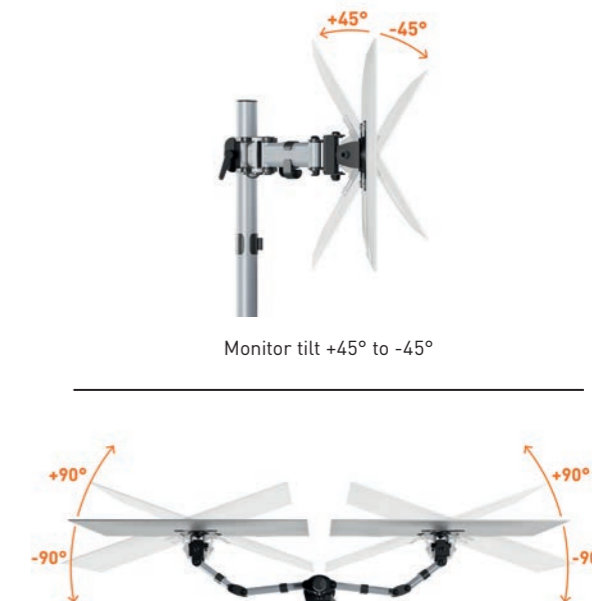

Monitor tilt +45° to -45°



Monitor panning +90° to -90°

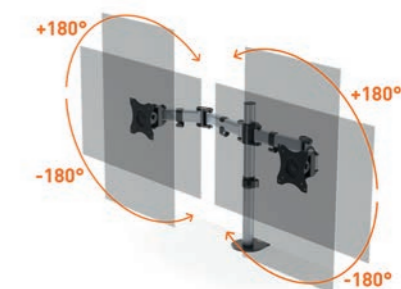

Monitor rotation +180° to -180°



Monitor Mount SELECT for 1 monitor

- For standard monitors up to 27" and 8 kg
- Flexibly extendable up to 43 cm on a 45 cm high column
- Universal VESA mount (75x75 mm or 100x100 mm)
- Cable management with clips to protect against cable breakage
- Sustainable packaging made from recycled material

Code	Colour	Version	Packaging
5094-...	●23	for 1 monitor	1 piece

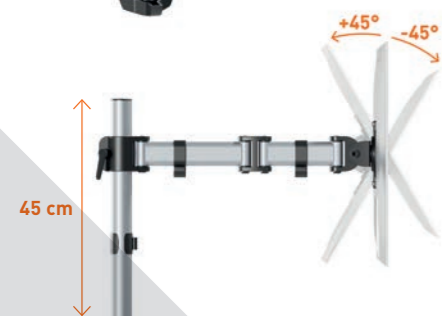

Monitor tilt +45° to -45°



Monitor panning +90° to -90°

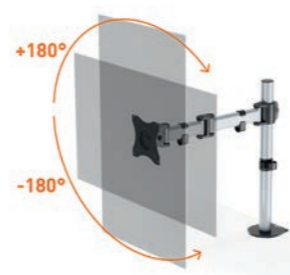

Monitor rotation +180° to -180°



Included

2 mounting options:
Table clamp and table grommet





TIP

Protect your display from unwanted glances:
With laptop privacy filters from DURABLE you can work safely on sensitive data – ideal for on the go and busy environments.



For PC and Apple Laptops from 11,6" to 16"
More information on durable.eu



LAPTOP STAND FOLD

Ergonomic on the move

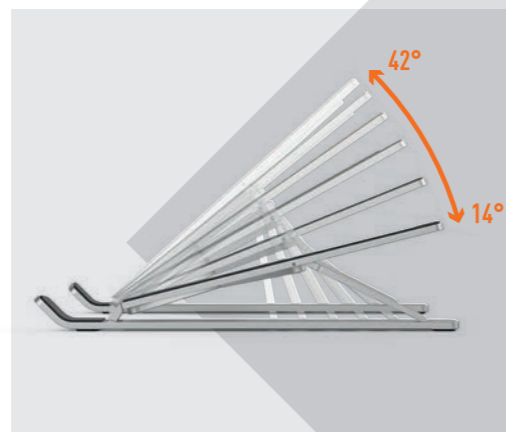

Adjustable tilt angle



Optimal air circulation

LAPTOP STAND RISE

Move to eye level



Infinitely adjustable



Improved heat dissipation



Non-slip rubber pads

Compact table stand for laptops and tablets up to 15"

- Space-saving foldable and easily portable
- Height adjustable in 6 easy steps
- Facilitates ergonomic working with its flexible height and tilt angle adjustability
- Maximum load capacity: 5 kg
- Non-slip rubber pads protect against scratches
- Includes practical travel bag

Code	Colour	Packaging
5051-...	●23	1 piece



Universal adjustable stand for laptops and tablets from 10" to 17" (up to 5 kg)

- Facilitates ergonomic work through infinitely variable height and reading angle adjustment
- High stability for safe working
- Non-slip rubber pads protect against scratches
- Space-saving foldable and mobile
- Improved heat dissipation due to ventilation holes and aluminum plate
- Extremely robust made of 3.5 mm thick aluminum, to support laptops permanently and reliably

Code	Colour	Packaging
5050-...	●23	1 piece



TIP

Enables the use of laptops as desktop screen (in combination with external keyboard and mouse)



NEW

DURABLE-EFFECT

EFFECT. FOR US.



REFUSE: Raw material reduction through 60% rPET, space-saving shipping
REDUCE: The guide rails are extracted from the bottom of the drawer box
REUSE: Foldable desk pad becomes a decorative after-work decoration
RECYCLE: Conserves resources through the use of 60% recycled PET



Desk mat EFFECT

- Desk mat made from 60% recycled PET felt with fold-out mobile phone holder
- The pleasant surface of the desk pad offers a first-class writing experience while protecting tables from scratches and marks
- Individual use: the mobile phone holder can be effortlessly folded out and folded back in without the cut-outs being visible
- The desk pad is made of an easy-to-clean material. The surface can simply be wiped clean with a damp cloth
- The felt material has a positive effect on acoustics by effectively absorbing disturbing noises

Code	Colour	Packaging
7081-...	●58	1 piece

EFFECT on ...

- Ergonomics** – thanks to 3-position height adjustment
- Haptics** – due to the pleasant surface of the desk pad
- Acoustics** – through noise reduction
- Well-Being** – through an appealing working environment
- Work-life blending** – thanks to the desk pad that becomes decoration
- Home office design** – through products that, thanks to harmoniously into any environment
- Use of smart solutions** – through integrated mobile phone holder



Home office becomes apart of your home:
The desk pad can be easily folded in half.



Monitor Stand EFFECT

- Stand for monitors and laptops made from recycled PET felt
- Triple height-adjustable for an ergonomically correct posture when working with monitors
- Various cable outlets for a clean desk

Code	Colour	Packaging
5081-...	●58	1 piece

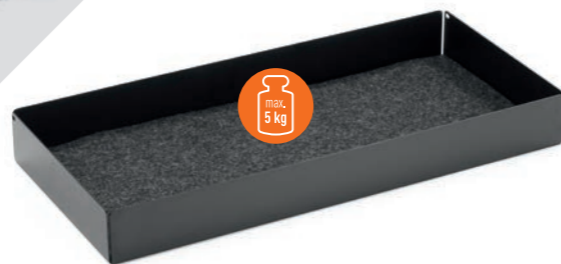

Drawer for Monitor Stand EFFECT

- Stand for monitors and laptops made from recycled PET felt
- Safely stowed away: with noise-reducing felt inlay in the drawer

Code	Colour	Packaging
5082-...	●01	1 piece



→ Visit durable.eu to view the entire range



Mobility guaranteed

The space-saving variant:
Universal tablet stand
TABLET STAND RISE (# 894023)
for tablets and smartphones.
Made of high quality aluminum.



Compatible with 7" to 13" tablets.
More information on durable.eu

TABLET HOLDER FLOOR

- The timeless floor stand for a first-class presentation in public buildings, at exhibitions, in hotels and restaurants as well as at the point of sale
- With cable channel and USB connection cable included in delivery

Code	Colour	Packaging
8932-...	●23	1 piece



TABLET HOLDER

For flexible use

An attractive system of technically advanced tablet holder solutions for a wide range of applications.

- Aluminum, steel and high quality plastics
- Compatible with all tablet formats from 7" to 13"
- Convenient one hand operation
- Rotates 360°
- Infinitely adjustable reading angle
- Effective anti-theft protection



TABLET HOLDER TABLE

- For the professional use of tablets in offices, public buildings as well as in exhibition and sales rooms
- With flexible angle adjustment and non-slip base

Code	Colour	Packaging
8930-...	●23	1 piece



TABLET HOLDER TABLE CLAMP

- Universal application possibilities: e.g. relaxed working and presentation work and presentations in the office and home office
- Ergonomic working due to flexible tilt range from -6° to +46°

Code	Colour	Packaging
8931-...	●23	1 piece

For tablets with protective cover

TABLET HOLDER TABLE XL

- Ideally suited for the professional use of tablets in manufacturing and logistics
- Tablets with protective cover can be inserted into the variable and 23 mm deep module, in order to use the safe use of the devices in the industrial sector
- With flexible reading angle adjustment and non-slip stand

Code	Colour	Packaging
8937-...	●23	1 piece



Effective protection against lateral removal of the tablet PC:
Anti-theft protection by inserting the dust-free adhesive strip





MADE IN GERMANY
DURABLE.EU

Highly variable

Ingeniously simple:
Universal wall mount **VISIOCLIP** (# 893958)
for tablets and smartphones.
Simple and individual mounting of the two clips
by gluing or drilling.



For devices weighing up to 1 kg
and a maximum depth of 10 mm.
More information on durable.eu



TABLET HOLDER

Suitable for any wall

Our tablet holder have an award winning design and made in Germany. Aluminum, steel and high-quality plastics ensure long term use.



TABLET HOLDER WALL

- Universal applications: e.g. trade fairs, office areas as well as sales and exhibition rooms
- Variable use in portrait and landscape format (snap-in points at 90° each)

Code	Colour	Packaging
8933-...	●23	1 piece



TABLET HOLDER WALL ARM

- Universal applications: e.g. multiple workstations, interactive infopoints, smart home
- Support arm projection: 365 mm, rotatability: ±180°

Code	Colour	Packaging
8934-...	●23	1 piece



TABLET HOLDER WALL PRO

- Can be used in industrial as well as in private environments
- Simple installation of the adapter for wall and ceiling connection

Code	Colour	Packaging
8935-...	●23	1 piece

For tablets with protective cover



TABLET HOLDER WALL XL

- Ideal for an application in the industrial sector
- Secure tablet holder with a protective cover (can also be used without cover) through extra deep module (23 mm)
- Easy mounting of the adapter for wall-mounting

Code	Colour	Packaging
8938-...	●23	1 piece



Ideal for smart home applications



NEW

TWIST – HOLDER FOR TABLETS AND MOBILE PHONES

Unlimited flexibility – at home and on the move



- Tablet holder TWIST TABLE**
- Table stand with tablet and mobile phone holder, equipped with flexible arm and ball joint
 - Suitable for all mobile phones and tablets as well as iPad and iPhone from 4.7" – 13", up to 800 g
 - Particularly ergonomic thanks to the flexible gooseneck, which allows individual and infinitely variable height adjustment
 - Integrated cable outlet in the clamp for cable management
 - Can be adjusted to any angle by 360-degree rotation
 - Can be used in landscape and portrait format

Code	Colour	Packaging
8941-...	●01	1 piece



Safe: Anti-slip pads in the clamp keep the tablet stable and additionally protect it from scratches.



Stable: Heavy metal base for a secure stand.



Clever combination

The **TWIST COMBI** tablet holder set combines the table and floor stand variants. Depending on the intended use, the supplied clamp can be fixed to the table or floor stand.



Code	Colour	Packaging
8943-...	●01	1 Set

Tablet holder TWIST FLOOR

- Floor stand with tablet and mobile phone holder, equipped with flexible arm and ball joint
- Suitable for all mobile phones and tablets as well as iPad and iPhone from 4.7" – 13", up to 800 g
- Telescopic rod allows the tripod to be adjusted to any height up to 1.69 m
- Folded down to 70 cm and stored in the supplied carrying bag, the tripod is mobile and flexible in use
- The flexible gooseneck allows individual and stepless height adjustment
- Anti-slip pads in the clamp hold the tablet firmly and also protect it from scratches
- Integrated cable outlet in the clamp for cable management
- Can be adjusted to any angle through 360-degree rotation
- Can be used in landscape and portrait format

Code	Colour	Packaging
8942-...	●01	1 piece

Practical: The floor stand is supplied with a high-quality carrying bag.





Mobile TV cart COWORKSATION®

Hybrid working requires flexible equipment

MADE IN GERMANY
DURABLE.EU



Flexible media cart for communication and presentation in smaller teams

- Flexible and safe in motion (75 mm castors with brake function)
- Mobile and easy to use with handle and cable holder
- Integrated cable management
- High-quality bonded CDF body offers several openings for cable routing and heat dissipation
- Storage compartments for accessories, such as Mini-PC, 3-way socket strip, remote control, mouse, keyboard, cables etc.
- Build up in a few steps
- Universal VESA mount (75x75 to 200x200 mm)
- For monitors 19" - 43", up to 18 kg

Code	Colour	Packaging
3702-...	O02	1 piece



COWORKING + CONVERSATION = COWORKSATION®

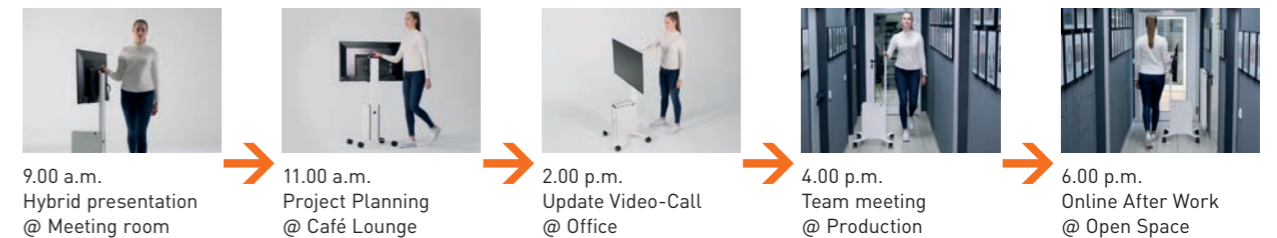

→ Visit durable.eu to view the entire range

CAVOLINE®

Modern cable management

CAVOLINE® BOX

- Elegant and exclusive cable box
- For holding cables and a 3- or 5-socket power strip
- Rubberised cable outlet slots on both sides for easy handling and excellent ventilation
- Easy to charge mobile devices thanks to round cable opening in lid
- High quality, flame retardant plastic
- Large rubber feet for a secure stand

MADE IN GERMANY

DURABLE.EU



TIP

Clever helpers:

The cable clips and hook and loop ties from DURABLE keep your cables together and thus ensure more efficiency, a better appearance and increased safety at the workplace.

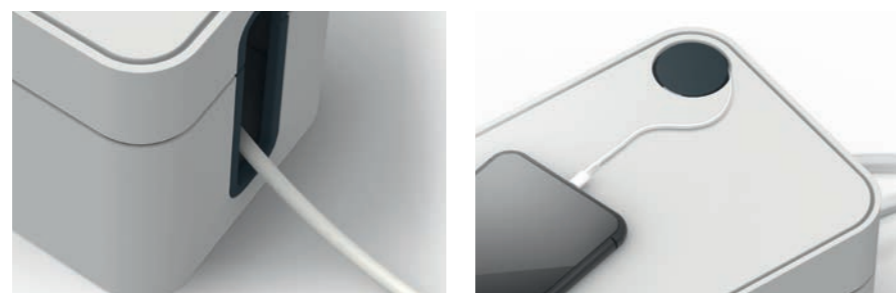

CAVOLINE® BOX S

- Dimensions: 246×116×128 mm (W×H×D)

Code	Colour	Packaging
5035-...	● 10 ● 37	1 piece

CAVOLINE® BOX L

- Dimensions: 406×156×139 mm (W×H×D)

Code	Colour	Packaging
5030-...	● 10 ● 37	1 piece



More information on durable.eu



DURABLE · Hunke & Jochheim GmbH & Co. KG
Westfalenstraße 77-79 · 58636 Iserlohn
Postfach 1753 · 58634 Iserlohn
T +49 (0)23 71 662-0
F +49 (0)23 71 662-221
durable@ durable.de · durable.de

INTERNATIONAL

DURABLE · Hunke & Jochheim GmbH & Co. KG
Westfalenstraße 77-79 · 58636 Iserlohn
P.O. Box 1753 · 58634 Iserlohn · Germany
P +49 (0)23 71 662-0
F +49 (0)23 71-662-221
durable@ durable.de · durable.eu

IT

DURABLE Italia S.R.L
Via Dottor Pietro Greppi, 15/B
23824 Dervio (LC)
T +39 (0)341 807806
info@durable.it · durable.it

BE

DURABLE Belgium N.V./S.A.
Industriepark 14/101 · 9031 Gent-Drongen
T +32 (0)9 281 26 44
F +32 (0)9 281 26 29
durable@ durable.be · durable.be

NL

DURABLE Nederland B.V.
Monierweg 3 · 7741 KV Coevorden
T +31 (0)416 543 543
F +31 (0)416 543 058
durable@ durable.nl · durable.nl

CZ

DURABLE · Hunke & Jochheim GmbH & Co. KG
Westfalenstraße 77-79 · 58636 Iserlohn
P.O. Box 1753 · 58634 Iserlohn · Germany
T +420 770 197 599
durablecz@durable.de · durable.cz

PL

Biuro Obsługi Klienta DURABLE Polska
Al.Kasztanowa 10 · 72-005 Przecław
T +48 (0)91 432 40 70
F +48 (0)91 432 40 83
bok@durable.pl · durable.pl

DK

DURABLE DENMARK
Branch of **DURABLE SCANDINAVIA AB**
Kovangen 302 · 3480 Fredensborg
T +45 (0)78 76 90 20
ordre@durable.dk · durable.dk

SE

DURABLE SCANDINAVIA AB
Fågelsångsvägen 4B · 186 42 Vallentuna
Box 4 · 186 21 Vallentuna
T +46 (0)8-630 11 50
info@durable.se · durable.se

ES

DURABLE · Hunke & Jochheim GmbH & Co. KG
Westfalenstraße 77-79 · 58636 Iserlohn
P.O. Box 1753 · 58634 Iserlohn · Germany
T +34 699 822 086
informacion@durable.de · durable.com.es

UK

DURABLE (UK) Ltd.
10 Nimrod Way, Wimborne, Dorset, BH21 7SH
P +44 (0)1202 89 70 71
F +44 (0)1202 87 33 81
customeroperations@durable-uk.com
durable-uk.com

FR

DURABLE France S.A.S
Immeuble Le Tryalis · 9, rue de Rosny · 93100 Montreuil
T +33 (0)1 48 12 10 90
F +33 (0)1 48 55 05 09
durable@ durable.fr · durable.fr

US

DURABLE Office Products Corp.
455 W Kay Ave · Addison, IL 60101
P +1 (0)800 273 31 18/847 787 01 00
F +1 (0)847 787 03 11
customerservice@durableofficeproducts.com
durable-north-america.com

